



Screed-covered cable duct Information



System overview

Floor trunking systems

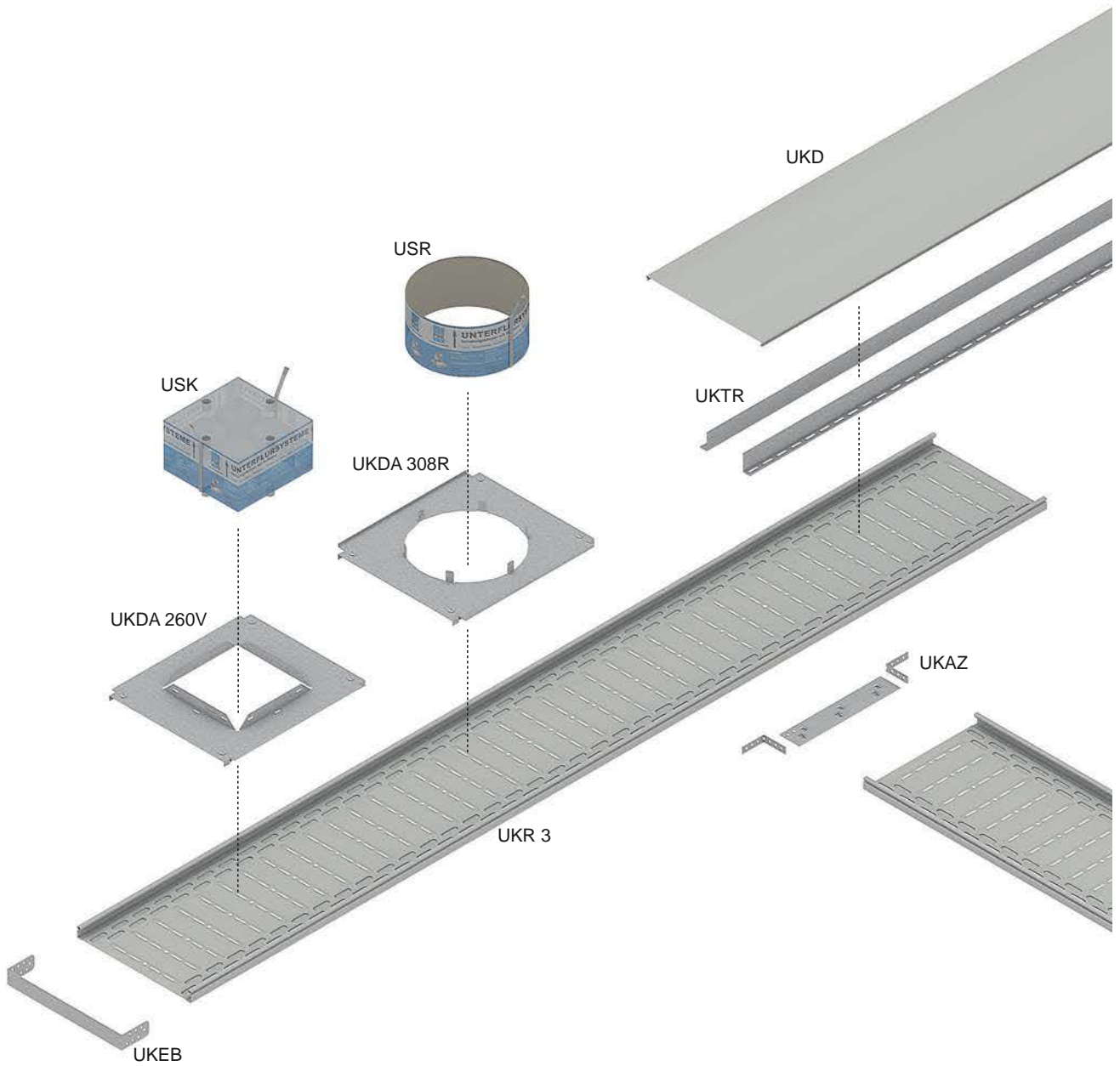

Screed-covered cable duct

Information

UKR 2 cable duct bottom piece 2 compartments

The screed-covered cable duct includes the following components: 1x lower part of cable duct UKR, 1x cable duct dummy lid UKD and 1x separating strip UKTR with corresponding installation and connection materials.

article number	H mm	B mm	L mm	G kg
S				
UKR 35-30S	35	300	3000	8,90

accessories included:

1 x **UKTR 35S** barrier strip
3 x **SNA 6x30/5** nail plug

accessories optional:

VB connection plate

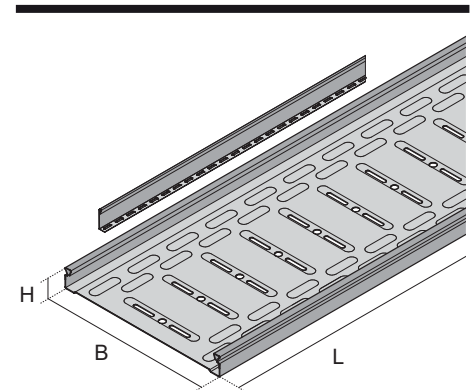

UKR 3 cable duct bottom piece 3 compartments

The screed-covered cable duct includes the following components: 1x lower part of cable duct UKR, 1x cable duct dummy lid UKD and 2x separating strip UKTR with corresponding installation and connection materials.

article number	H mm	B mm	L mm	G kg
S				
UKR 35-40S	35	400	3000	14,20
UKR 35-50S	35	500	3000	15,40

accessories included:

2 x **UKTR 35S** barrier strip
6 x **SNA 6x30/5** nail plug

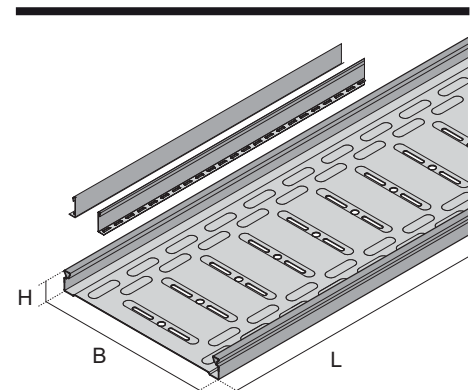

article number	H mm	B mm	L mm	G kg
S				
UKR 60-40S	60	400	3000	19,80
UKR 60-50S	60	500	3000	23,90

accessories included:

2 x **UKTR 60S** barrier strip
6 x **SNA 6x30/5** nail plug

article number	H mm	B mm	L mm	G kg
S				
UKR 85-40S	85	400	3000	23,40
UKR 85-50S	85	500	3000	27,50

accessories included:

2 x **UKTR 85S** barrier strip
6 x **SNA 6x30/5** nail plug

article number	H mm	B mm	L mm	G kg
S				
UKR 110-40S	110	400	3000	28,70
UKR 110-50S	110	500	3000	31,00

accessories included:

2 x **UKTR 110S** barrier strip
6 x **SNA 6x30/5** nail plug

accessories optional:

VB connection plate

Screed-covered cable duct

Information

UKD dummy cover for cable duct

article number	B mm	L mm	P _{max} kN	G kg
S				
UKD 30S	300	3000	0,75	7,90
UKD 40S	400	3000	0,75	10,20
UKD 50S	500	3000	0,75	19,00

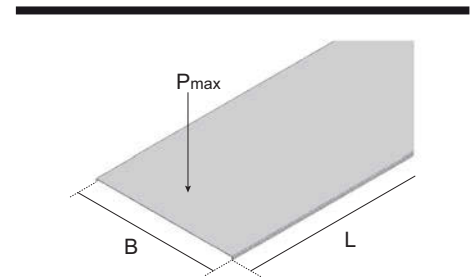

UKDA 308R cable duct assembly cover, round

article number	B mm	L mm	E mm	P _{max} kN	G kg
S					
UKDA-308R 40S	400	495	310	0,75	2,30
UKDA-308R 50S	500	595	310	0,75	3,90

accessories included:
1 x **UBDHB-Z** grounding clamp

accessories optional:
USR shuttering tube
UBDEL grounding lug

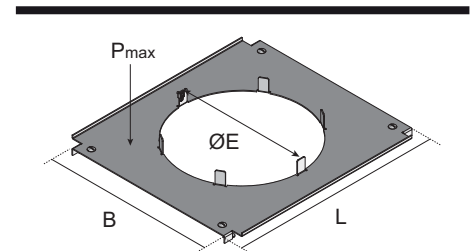

UKDA 260R cable duct assembly cover, round

article number	B mm	L mm	E mm	P _{max} kN	G kg
S					
UKDA-260R 30S	300	420	260	0,75	1,23
UKDA-260R 40S	400	495	260	0,75	2,14
UKDA-260R 50S	500	595	260	0,75	4,47

accessories included:
1 x **UBDHB-Z** grounding clamp

accessories optional:
USR shuttering tube
UBDEL grounding lug

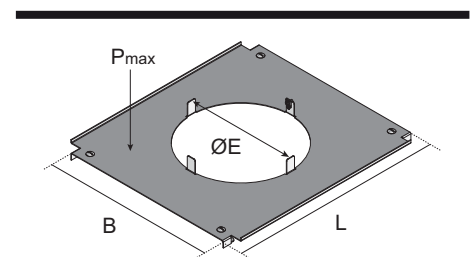

UKDA 260V cable duct assembly cover, quadrangular

article number	B mm	L mm	E mm	P _{max} kN	G kg
S					
UKDA-260V 40S	400	495	262 x 262	0,75	2,03
UKDA-260V 50S	500	595	262 x 262	0,75	3,29

accessories included:
1 x **UBDHB-Z** grounding clamp

accessories optional:
USK shuttering unit quadrangular
UBDEL grounding lug

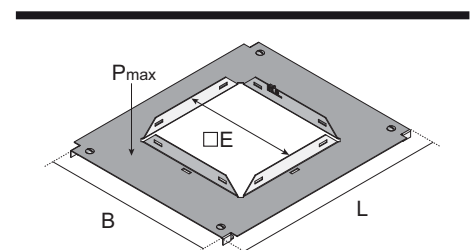

Screed-covered cable duct

Information

UKDA 185V cable duct assembly cover, quadrangular

article number	B mm	L mm	E mm	P _{max} kN	G kg
S					
UKDA-185V 30S	300	420	187 x 262	0,75	1,39
UKDA-185V 40S	400	495	187 x 262	0,75	2,26

accessories included:
1 x **UBDHB-Z** grounding clamp

accessories optional:
USK shuttering unit quadrangular
UBDEL grounding lug

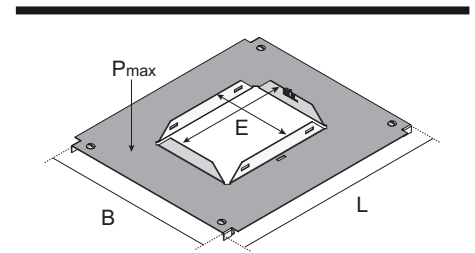

UKEB end piece

article number	H mm	B mm	G kg
S			
UKEB 35-30S	20	300	0,13
UKEB 35-40S	20	400	0,16
UKEB 35-50S	20	500	0,19
UKEB 60-40S	45	400	0,31
UKEB 60-50S	45	500	0,36

accessories included:
1 x **KLR** clamping assembly

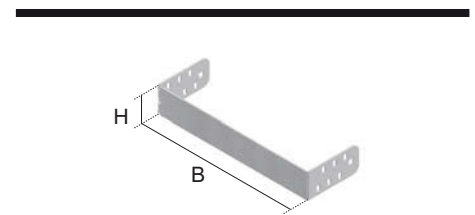

article number	H mm	B mm	G kg
S			
UKEB 85-40S	70	400	0,64
UKEB 85-50S	70	500	0,75
UKEB 110-40S	95	400	0,93
UKEB 110-50S	95	500	1,10

accessories included:
2 x **KLR** clamping assembly

UKAZ extension accessories

article number	H mm	B mm	G kg
S			
UKAZ 35-30S	20	300	0,40
UKAZ 35-40S	20	400	0,50
UKAZ 35-50S	20	500	0,60
UKAZ 60-40S	45	400	1,20
UKAZ 60-50S	45	500	1,30
UKAZ 85-40S	70	400	1,40
UKAZ 85-50S	70	500	1,60
UKAZ 110-40S	95	400	1,70
UKAZ 110-50S	95	500	1,80

accessories optional:
SNA nail plug

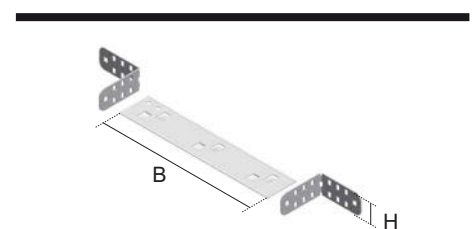

Screed-covered cable duct

Information

UKTR barrier strip

article number	H mm	L mm	G kg
S			
UKTR 35S	33	3000	1,60
UKTR 60S	57	3000	2,10
UKTR 85S	80	3000	2,80
UKTR 110S	107	3000	4,80

accessories optional:
SNA nail plug

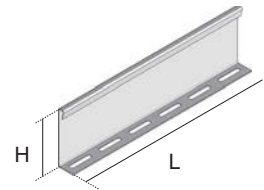

USR shuttering tube

Cardboard shuttering tube for the construction of an installation opening for round installation units. To be used in a hollow space floor box.

Caution: insulating strip of max. thickness of 2 mm!

article number	H mm	D mm	G kg
KT			
USR 308-150	150	308	0,42
USR 308-225	225	308	0,60
USR 259-150	150	260	0,30

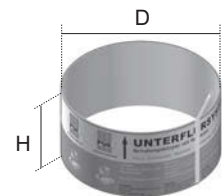

USK shuttering unit quadrangular

Polystyrene shuttering unit for the construction of an installation opening for quadrangular installation units. To be used in a hollow space floor box.

Caution: insulating strip of max. thickness of 2 mm!

article number	H mm	B mm	L mm	E mm	G kg
STY					
USK 259V-225	225	262	262	262x262	0,24
USK 259V-150	150	262	262	262x262	0,19
USK 185V-150	150	262	186	187x262	0,16
USK 160V-150	150	163	163	165x165	0,08

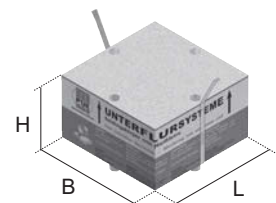

Scree-covered cable duct

Assembly instruction

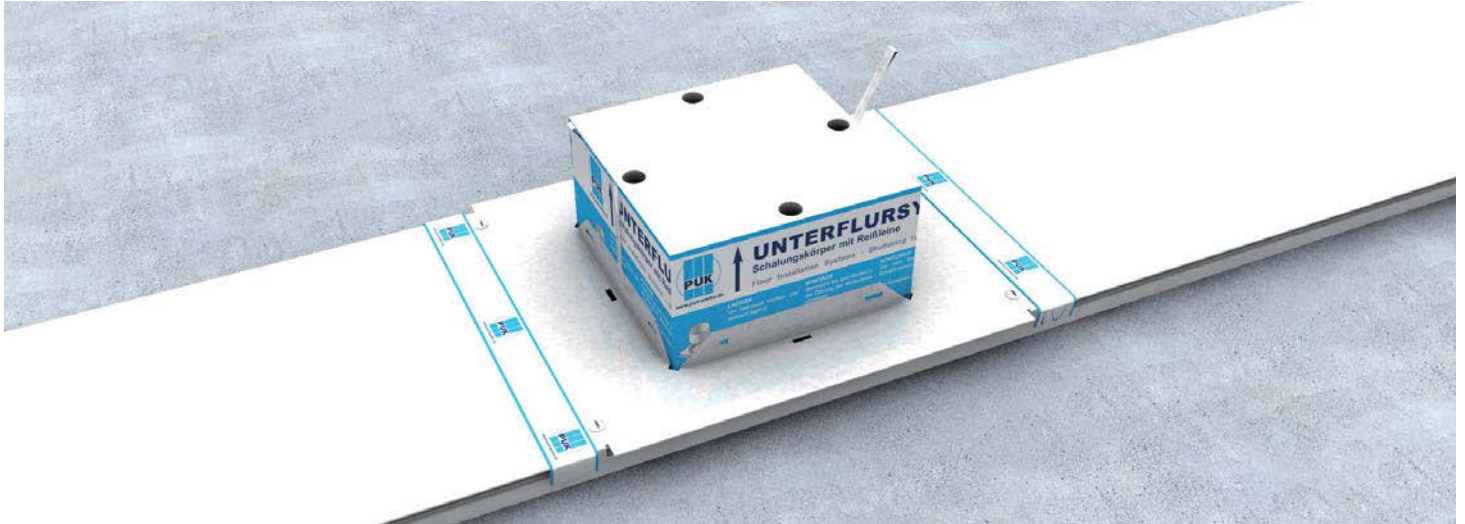

Open, two- respectively three compartment cable duct UKR in the nominal widths $B = 300, 400$ and 500 mm, made of steel sheet with length L of 3000 mm. In heights of $35, 60, 85$ and 110 mm. Loading capacity up to $0,75$ kN. Consisting of a bottom piece with a barrier strip and a separate top piece.

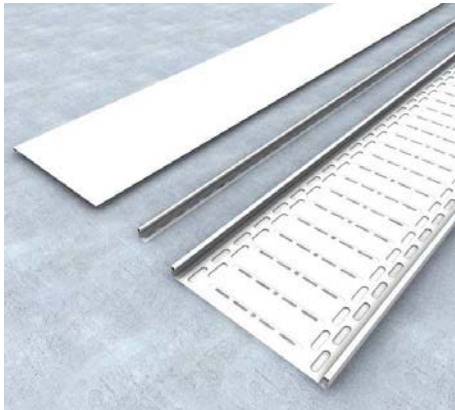

1 | UKR
The scree-covered cable duct consists of a duct bottom piece UKR, a cable duct dummy cover UKD and one, respectively two barrier strips UKTR, including the necessary material for mounting and connecting.

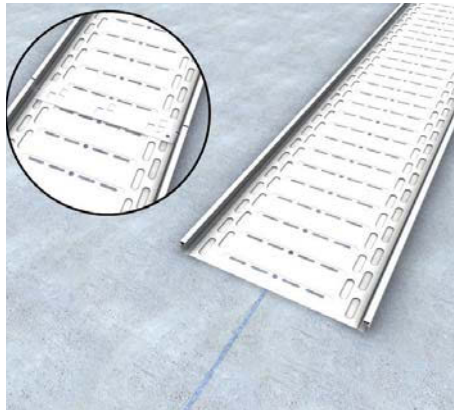

2 | Duct alignment
Measure the duct course according to the approved layout drawing and mark it using a plumb line. Lay bottom piece according to duct course and marking and align in dead centre. Cut ducts and push flush together using the coupler plate VB.



3 | Fixing
Mount duct to the rough concrete in one place per length using plugs.



4 | Junction
In order to create a junction, notch the duct bottom piece according to the width of the duct branch.



5 | Barrier strip
Always fasten barrier strips UKTR symmetrically to the rough concrete using plugs once per metre.



6 | Fastening of barrier strip
Barrier strips must be mounted in parallel offset of the duct.

Screed-covered cable duct

Assembly instruction

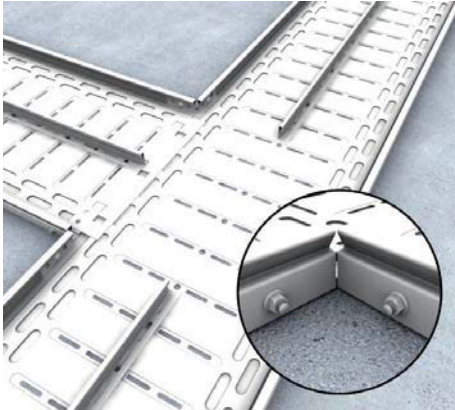

7 | Fitting components

T-extensions, junctions, and 90°bends can be created by notching the duct. Screw couplers together on the inside.

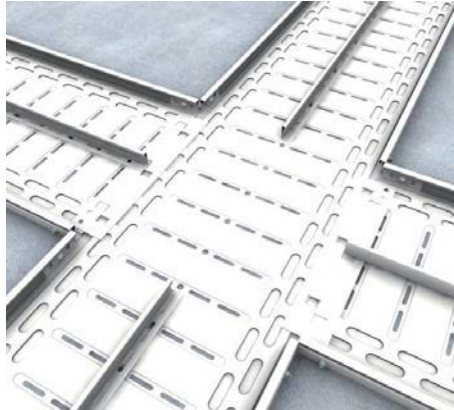

8 | Duct segments

The duct segments are connected by means of extension accessories UKAZ.

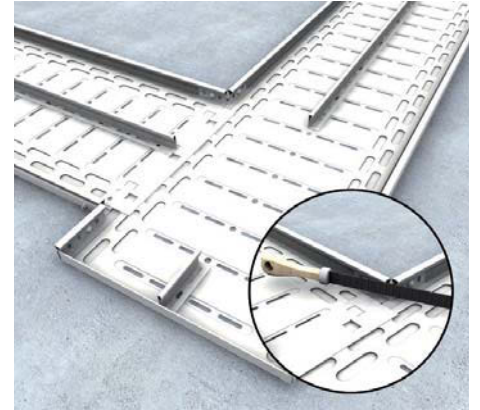

9 | Final assembly of fitting components

The barrier strips must be cut flush at the notches of the extensions and junctions. Trim the interfaces neatly and cold-galvanise.

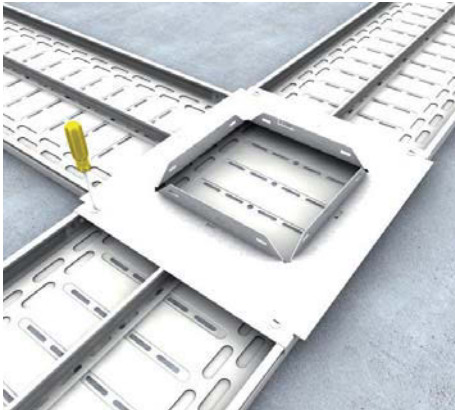

10 | Assembly cover fitting component

The levelled assembly covers UKDA are mounted to the duct using turning bolts. In case of a subsequent removal of the cover, mark position for the cable pull.

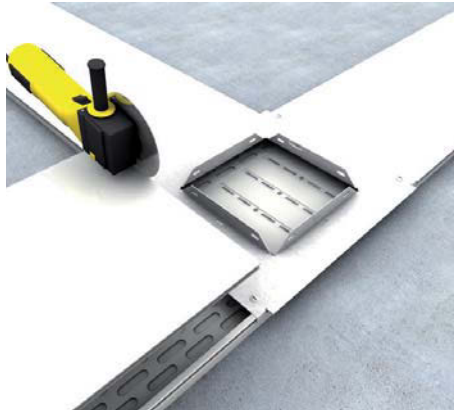

11 | Dummy covers

Cut dummy covers UKD accurate to measurement, place on the duct and then latch in.



12 | Shuttering unit

Insert shuttering unit straight, arrow pointing up, into the opening of the assembly cover. All open areas must be masked according to DIN before applying the screed.

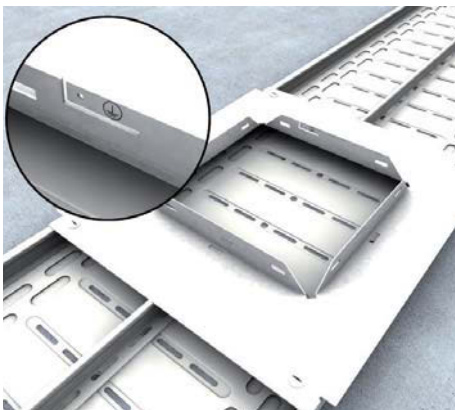

13 | Assembly cover

The assembly covers UKDA are levelled dead centre in duct course and mounted to the duct using turning bolts. All conductive parts must be considered in the potential equalisation.



14 | Duct assembly

Mount duct bottom piece and dummy cover on parallel offset.

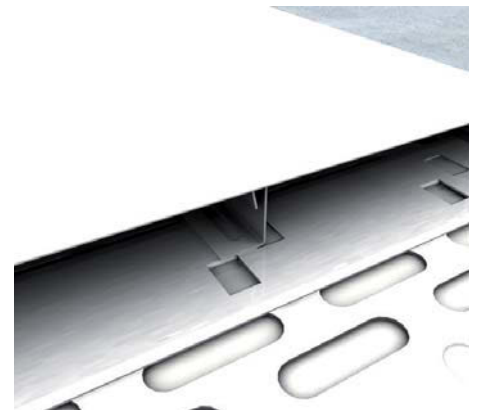

15 | Assembly opening

Barrier strips must not extend into the assembly opening, but must end 1-2 mm before.

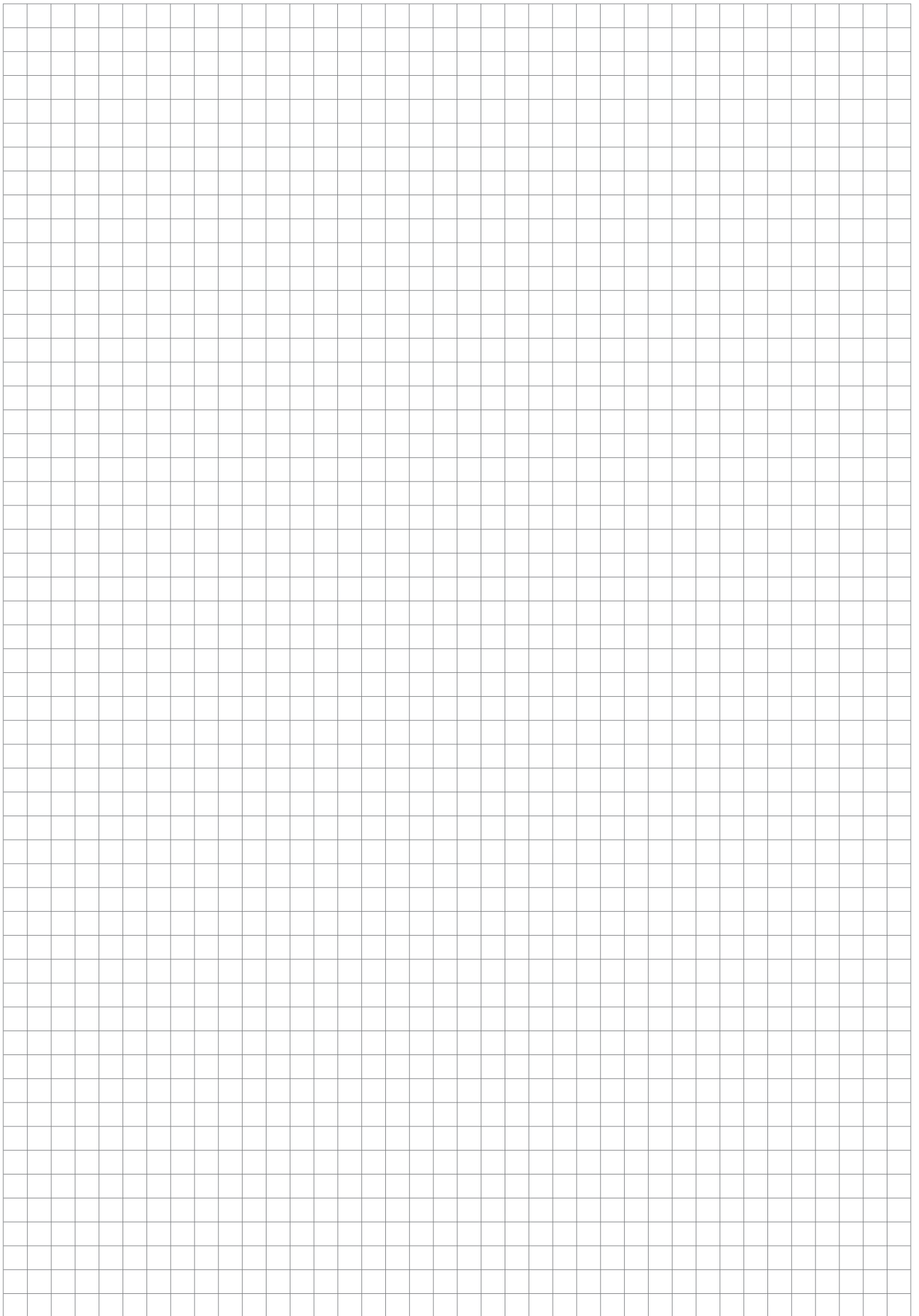



Irrtümer und technische Änderungen vorbehalten. Nachdruck sowie jegliche elektronische Vervielfältigung nur mit unserer schriftlichen Genehmigung. Mit Erscheinen dieser Drucksache verlieren alle vorhergehenden Unterlagen ihre Gültigkeit.

