



**Cartridge installation units  
made of stainless steel**  
Assembly instruction



# Cartridge installation unit made of stainless steel, quadrangular

## Assembly instruction

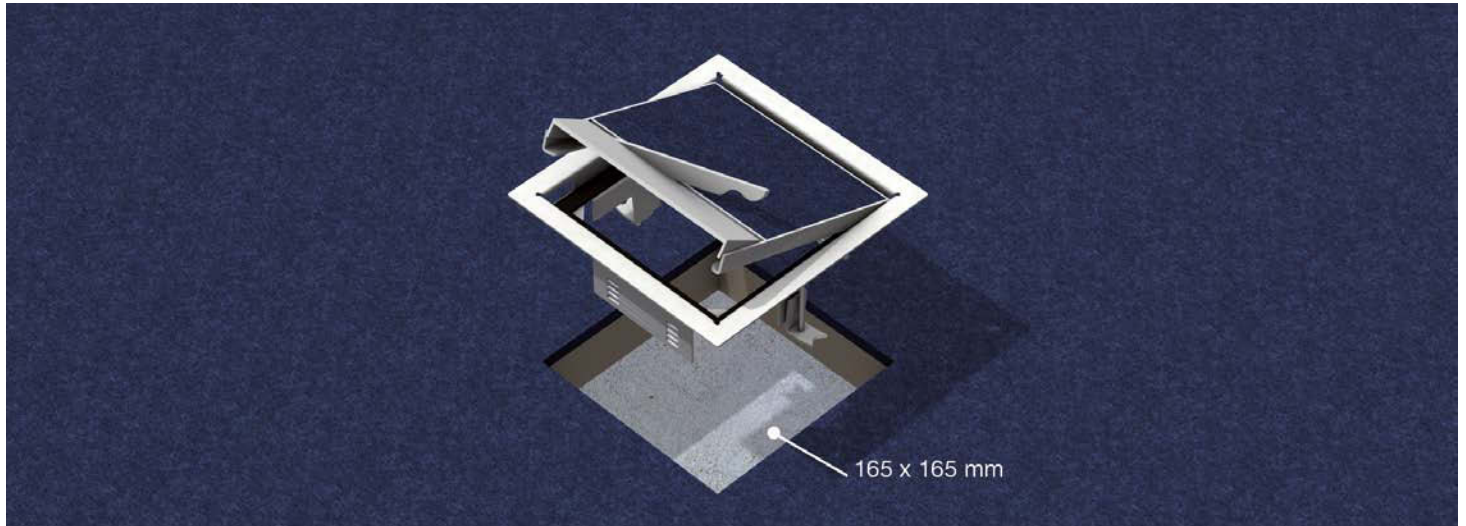

Quadrangular cartridge unit with carpet protection frame made of high-grade steel with outside measurements of 187x187 mm for the installation in hollow floors or raised floors, for a floor cover of 12/22 mm.

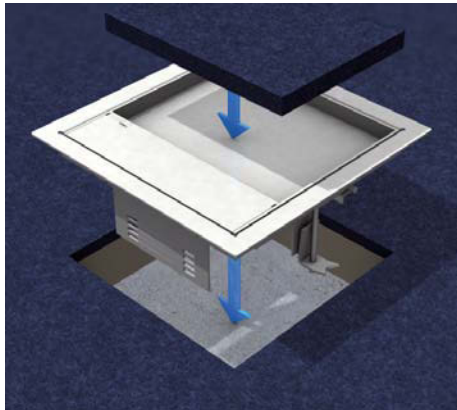

**1 | Unit**  
For the installation of a device cup, place cartridge unit UEKDD1-2 V E into the opening.

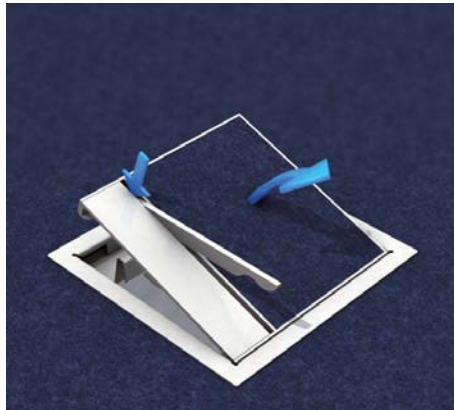

**2 | Opening lever**  
Activate the self-locking opening lever behind the cable outlet and lift the lid out of the frame sideways through the hinge.

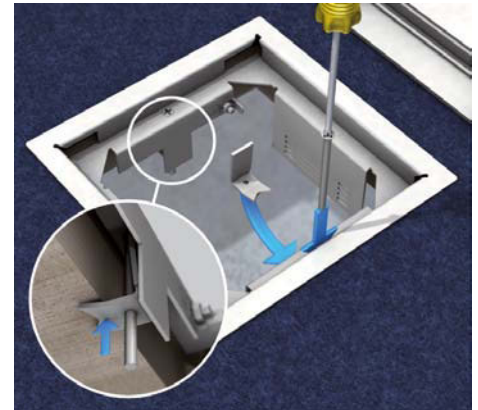

**3 | Mounting of claws**  
Hinge the enclosed claws with the corresponding screws into the holding fixtures in the frame. Bring the claws in the right position and pull tight with a crosshead screw. Make sure the frame sits tightly.

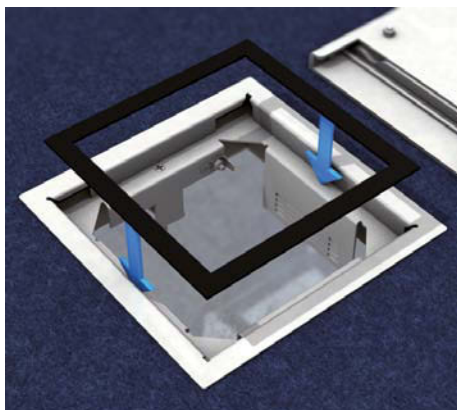

**4 | Rubber seal**  
Glue the rubber seal for impact-noise decoupling into the frame.

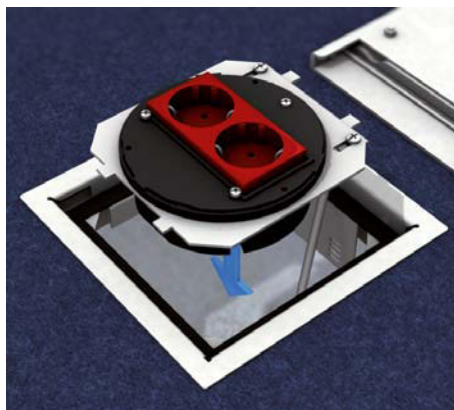

**5 | Inserting of device cup**  
Insert plate with the pre-mounted and loaded device cup through the plate slide as deep into the lock-in leads in the frame as possible. A gradual lowering of the plate to max 20 mm possible.

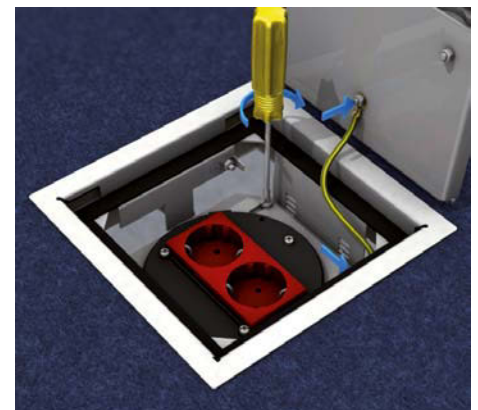

**6 | Earthing connection**  
Fixate the plate in the lock-in lead and make an earthing connection between the single outlet frame and the cover. Factor the installation unit into the potential equalization.

# Cartridge installation unit made of stainless steel, quadrangular

## Assembly instruction

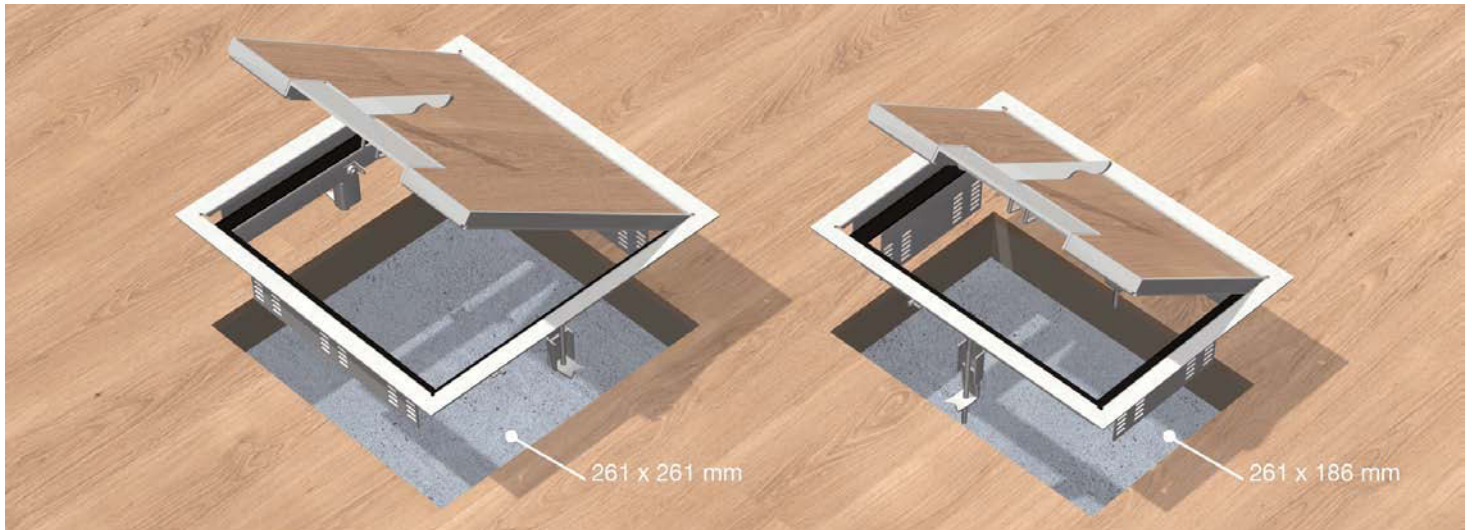

Quadrangular cartridge installation units with carpet protection frame made of high-grade steel with outer measurements of 284x284 mm or 284x211 mm for the installation in hollow space floors or raised floors. For parquet flooring of 12/22 mm.

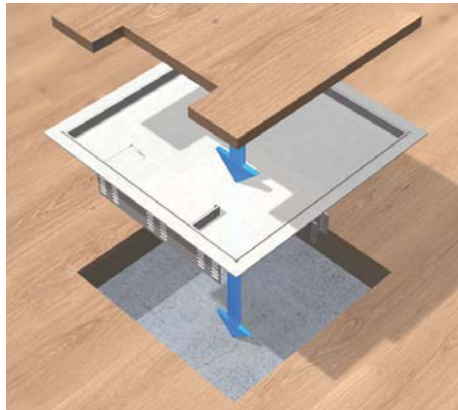

**1 | Unit**  
For the installation of up to 3 device cups, place the cartridge installation unit UEKDD V E into the opening.

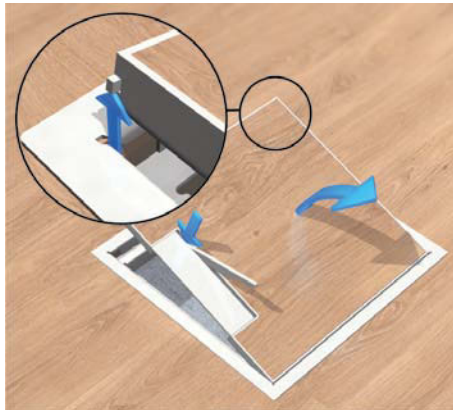

**2 | Opening lever**  
Open the self-locking opening lever behind the cable outlet. Remove the cover sideways over the hinge.



**3 | Claws**  
Hinge the enclosed claws with the corresponding screws into the frame guide and pull tight.

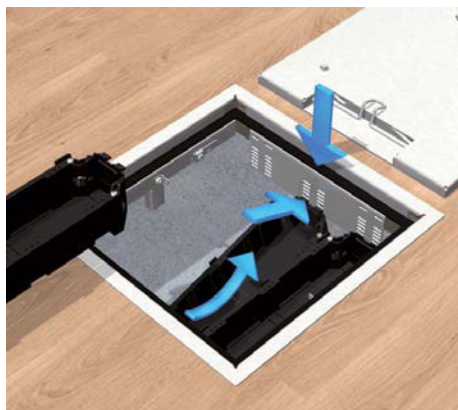

**4 | Rubber seal / Device cup**  
Glue the rubber seal to the impact-noise interface. Snap the device cup as deep into the lock-in leads as possible. When using an device plug  $H = 35 \text{ mm}$ , minimum installation depth  $H_{\text{min}} = 91 \text{ mm}$ .

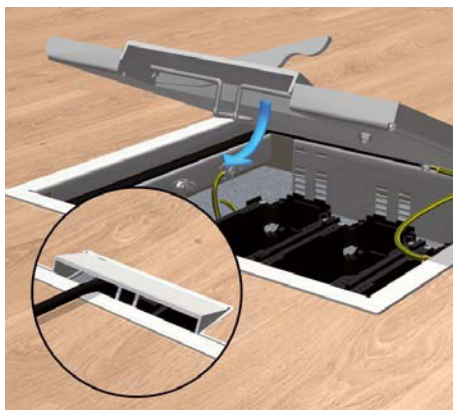

**5 | Axis**  
Open the cable outlet with the opening lever and swivel the cable outlet axis.



**6 | Earthing connection**  
Make an earthing connection between the frame and the cover. Factor the installation unit into the potential equalization.



Errors and technical modification subject to change, reproduction as well as electronic duplication only with our written permission. With appearance of this print all preceding documents lose their validity

